

UNIT - IV

TIME BASE GENERATORS

General features of a time base signal, methods of generating time base waveform, Miller and bootstrap time base generators - basic principles, transistor Miller time base generator, transistor bootstrap time base generator, current time base generators, methods of linearity improvements.

SYNCHRONIZATION AND FREQUENCY DIVISION

Principles of synchronization, frequency division in sweep circuits, Astable Relaxation circuits, Monostable Relaxation circuits, synchronization of a sweep circuit with symmetrical signals, sine wave frequency division with a sweep circuit

Time Base Generators

Introduction

Time base generator

"It is an electronic circuit which generates an output voltage (or) current waveform, a portion of which varies linearly with time".

Classification

- 1) Voltage time-base generator
- 2) Current time-base generator

Voltage time-base generator

A voltage time base generator is one that provides an output voltage waveform, a portion of which exhibits a linear variation with respect to time.

Current time-base generator

It is one that provides an output-current waveform, a portion of which exhibits a linear variation with respect to time.

Ideally the waveform at the output should be a ramp.

Applications of time-base generators

- 1) In CRO's.
- 2) In Television.
- 3) In Radar displays.
- 4) In precise time measurements.
- 5) In Time modulation.

The most important application of time-base generators is in CRO's.

To display the variation with respect to time of an arbitrary waveform on the screen of an oscilloscope, it is required to apply to one set of deflecting plates a voltage which varies linearly with time i.e., for deflecting the electron beam horizontally across the screen.

Since the applied voltage makes to sweep the electron beam horizontally across the screen, it is called as sweep voltage and the time-base generators are called sweep generator or sweep circuit.

General features of a Time-Base Signal

Below fig(a) shows the typical wave form of a time-base voltage (Sweep voltage)

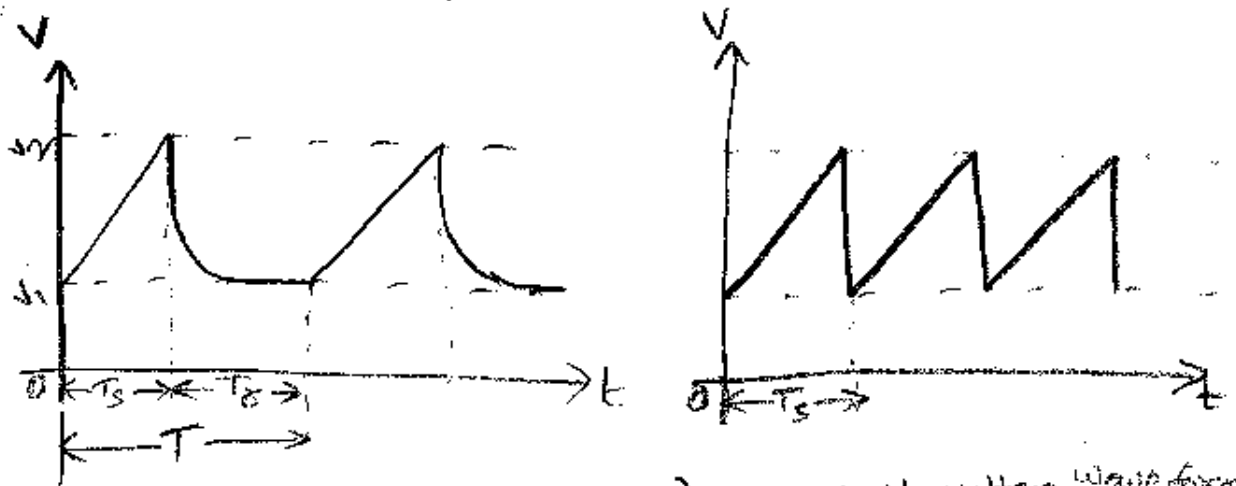

a) General sweep voltage b) Saw-tooth voltage wave form

It is seen that, the voltage starting from an initial value V_1 increases linearly with time to a maximum (peak) value V_2 after which it returns again to its initial value V_1 over a short period of time.

"The time taken by the waveform to reach the maximum value (V_2), starting from the initial value is called as sweep time (T_s)."

"The time during which it returns to the initial value (V_1) is called as return time or restoration time or fly-back time (T_r)."

$$T_r < T_s$$

— In most cases ~~the~~ of the waveform during restoration time and the restoration time itself are not of much consequence.

— However in some cases a restoration time which is very small compared with the sweep time is required in some application.

— If the restoration time is almost zero ($T_r=0$) and the next linear voltage is initiated the moment the present one is terminated then a sawtooth waveform is generated as shown in fig(b).

— The waveforms shown in fig(a) & (b) are called as sweep waveforms even when they are used in applications not involving the deflection of an electron beam.

Drawback

— In practice, the signals generated by time-base circuits are not perfectly linear. Additionally, even if the signals are linear, they suffer distortion when transmitted through a coupling network.

— The deviation of a signal from linearity is expressed in three types of errors:

- 1) The slope or sweep speed error (e_s).
- 2) Transmission error (e_t).
- 3) Displacement error (e_d).

1) sweep error (e_s):

— It is also called as sweep-speed error or slope error or slope-speed error.

— In case of general-purpose CRO, an important requirement of the sweep is that the sweep signal must increase linearly with time i.e.,
 "the rate of change of sweep voltage with time is constant."

— This deviation from linearity is defined as

$$e_s = \frac{\text{Difference in slope at the beginning and end of sweep}}{\text{Initial value of slope.}}$$

$$e_s = \frac{\left. \frac{dv_0}{dt} \right|_{t=0} - \left. \frac{dv_0}{dt} \right|_{t=T_s}}{\left. \frac{dv_0}{dt} \right|_{t=0}}$$

where Initial slope is at $t=0$
 Final slope is at $t=T_s$.

Note:

If a capacitor C is charged by a constant current I , then the voltage across C is $= \frac{Q}{C} = \frac{It}{C}$
 \therefore Rate of change of voltage with time $= \frac{It/C}{t}$

$$\therefore \text{Sweep speed } (e_s) = \frac{I}{C}$$

e) Transmission error (e_t):

— When a ramp signal is transmitted through a high-pass circuit, the output v_s falls away from the input.

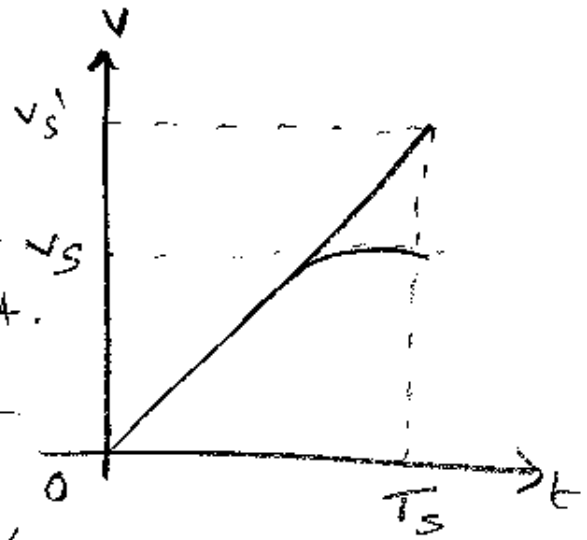

— At the end of T_s , the value of the voltage $v_s < v_s'$, due to the fact that it has deviated from linearity.

— This deviation is expressed as transmission error (e_t).

“It is defined as the difference between the input voltage and output voltage divided by the input voltage at the end of the sweep.”

$$\text{at } t = T_s, \text{ i/p} = v_s', \text{ o/p} = v_s$$

$$e_t = \frac{v_s' - v_s}{v_s'} = \frac{\text{Input} - \text{Output}}{\text{Input}}$$

3) Displacement error (e_d):

"It is defined as the ratio of the maximum difference (deviation) between the actual sweep voltage and linear sweep to the amplitude of the sweep at the end of sweep time."

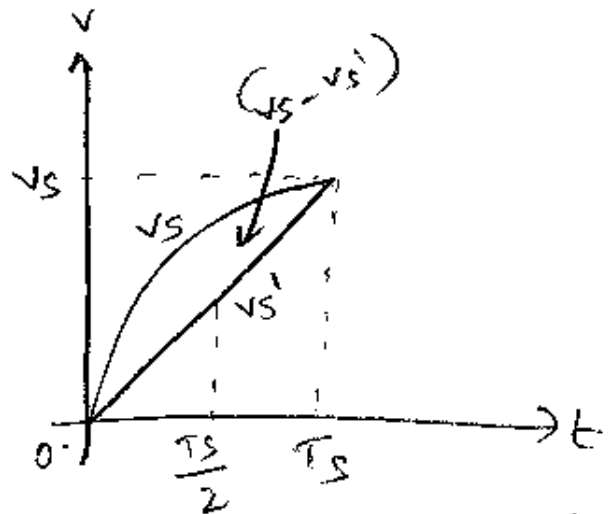

$$e_d = \frac{(V_s - V_s')_{\text{max}}}{V_s}$$

Methods of generating time base waveform

In time-base circuits, sweep linearity is achieved by one of the following methods:

1) Exponential charging

In this method, a capacitor is charged through a resistor to a voltage which is quite small as compared to the charging voltage (supply voltage). It is basically an RC differentiator circuit.

2) Constant-current charging

In this method, a capacitor is charged linearly from a constant current source.

Since the charging current is constant, the voltage across the capacitor increases linearly.

3) Miller circuit

In this method, a step voltage is converted into a ramp, using an operational integrating circuit like Miller integrator.

4) phantastan circuit

In this method, a pulse input is converted into a ramp. This is a version of the Miller circuit.

5) Bootstrap circuit

In this method, a constant current is passed through a capacitor and the voltage across the capacitor is a ramp.

Constant-current is obtained by maintaining a constant voltage across a fixed resistor in series with the capacitor.

Exponential Sweep Circuit

— Below fig shows an exponential sweep circuit.

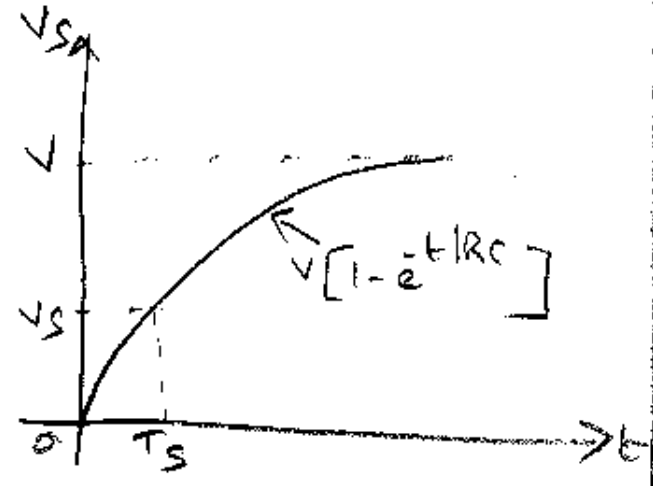
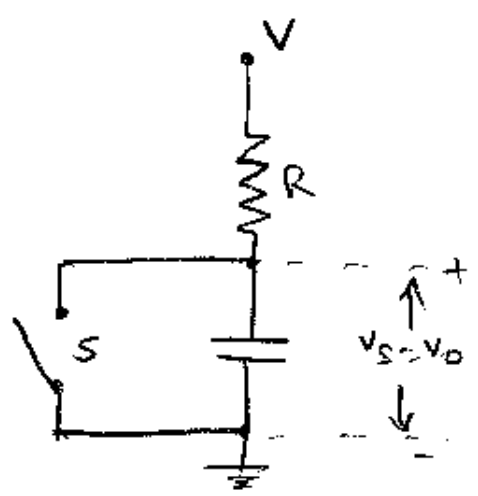

fig: charging a capacitor through a resistor from a fixed voltage

fig: Resultant exponential waveform across the capacitor

— the switch 'S' is normally closed and is open at $t=0$.

so, for $t > 0$, capacitor charges towards the supply voltage V with a time constant RC .

— The voltage across the capacitor at any instant of time is given by

$$V_c(t) = V [1 - e^{-t/RC}]$$

— After an interval of time T_s , when the sweep amplitude attains the value V_s , the switch again closes,

→ The relation between the three measures of linearity, namely e_s , e_t and e_f for an exponential sweep circuit is derived below:

1) slope error sweep speed error (e_s):

$$v_o(t) = V \left[1 - e^{-t/RC} \right] = V - Ve^{-t/RC}$$

∴ Rate of change of output at slope is

$$\frac{dv_o}{dt} = 0 - V \left(e^{-t/RC} \right) \left(-\frac{1}{RC} \right) = \frac{Ve^{-t/RC}}{RC}$$

$$\left. \frac{dv_o}{dt} \right|_{t=0} = \frac{Ve^{-0}}{RC} = \frac{V}{RC}$$

$$\left. \frac{dv_o}{dt} \right|_{t=T_s} = \frac{Ve^{-T_s/RC}}{RC}$$

$$e_s = \frac{\left. \frac{dv_o}{dt} \right|_{t=0} - \left. \frac{dv_o}{dt} \right|_{t=T_s}}{\left. \frac{dv_o}{dt} \right|_{t=0}}$$

$$e_s = \frac{\frac{V}{RC} - \frac{Ve^{-T_s/RC}}{RC}}{\frac{V}{RC}} = \frac{V/RC \left[1 - e^{-T_s/RC} \right]}{V/RC}$$

$$e_s = 1 - e^{-T_s/RC}$$

using binomial expansion

$$e^{-x} = 1 - \frac{x}{1!} + \frac{x^2}{2!} - \frac{x^3}{3!} \dots$$

$$e_s = 1 - \left[1 - \frac{\left(\frac{T_s}{RC}\right)}{1!} + \frac{\left(\frac{T_s}{RC}\right)^2}{2!} - \dots \right]$$

neglecting higher order terms

$$e_s = 1 - 1 + \frac{T_s}{RC} = \frac{T_s}{RC}$$

$$e_s = \frac{T_s}{RC}$$

(OB) we know $v_o = V \left[1 - e^{-t/RC} \right]$

at $t = T_s$, $v_o = V_s$

$$V_s = V \left[1 - e^{-T_s/RC} \right] = V \frac{T_s}{RC}$$

2) Transmission errors (e_t)

$$\frac{V_s}{V} = \frac{T_s}{RC}$$

$$e_s = \frac{V_s}{V}$$

$$v_s = V \left[1 - e^{-t/RC} \right]$$

$$= V \left[1 - \left\{ 1 - \frac{t}{RC} + \frac{(t/RC)^2}{2!} - \frac{(t/RC)^3}{3!} + \dots \right\} \right]$$

$$= V \left[1 - 1 + \frac{t}{RC} - \frac{(t/RC)^2}{2} \right]$$

neglecting higher order terms, since input is ramp, so consider upto second order

$$v_s = V \left[\frac{t}{RC} \left(1 - \frac{t}{2RC} \right) \right]$$

$$v_s = \frac{Vt}{RC} \left(1 - \frac{t}{2RC} \right)$$

at $t = T_s$, $v_s = V_s$

$$V_s = \frac{V T_s}{RC} \left(1 - \frac{T_s}{2RC} \right) \quad \text{--- (1)}$$

input (v_s) = αt , where slope, $\alpha = \frac{V}{RC}$

$$\frac{dv_o}{dt} \Big|_{t=0} = \dots$$

$$v_s' = \frac{Vt}{RC}$$

at $t = T_S$, $v_s' = v_s'$

$$v_s' = \frac{VT_S}{RC} \quad \text{--- (2)}$$

$$e_t = \frac{v_s' - v_s}{v_s'} = \frac{\frac{VT_S}{RC} - \frac{VT_S}{RC} \left(1 - \frac{T_S}{2RC}\right)}{\frac{VT_S}{RC}}$$

$$= \frac{\cancel{\frac{VT_S}{RC}} \left[1 - \left(1 - \frac{T_S}{2RC}\right)\right]}{\cancel{\frac{VT_S}{RC}}}$$

$$= \cancel{1} - \cancel{1} + \frac{T_S}{2RC}$$

$$\therefore e_t = \frac{T_S}{2RC} = \frac{e_s}{2}$$

3) Displacement error:

$$e_d = \frac{(V_s - V_s')_{\text{max}}}{V_s}$$

we know $V_s = \text{actual sweep} = V \left[1 - e^{-t/RC} \right]$

$$V_s = \frac{Vt}{RC} \left[1 - \frac{t}{2RC} \right]$$

$$V_s' (\text{ideal ramp on linear sweep}) = \alpha t = \left(\frac{V}{RC} \right) t$$

deviation:

$$V_s - V_s' = \frac{Vt}{RC} \left[1 - \frac{t}{2RC} \right] - \frac{Vt}{RC}$$

$$= \frac{Vt}{RC} \left[1 - \frac{t}{2RC} - 1 \right]$$

$$= -\frac{Vt}{RC} \cdot \frac{t}{2RC} \quad \text{--- (1)}$$

The deviation is maximum at $t = \frac{T_s}{2}$

\therefore maximum deviation at $t = \frac{T_s}{2}$ is $|V_s - V_s'|_{\text{max}}$

$$|V_s - V_s'|_{\text{max}} = \frac{V(T_s/2)}{RC} \cdot \frac{T_s/2}{2RC} \quad \text{--- (2)}$$

$$V_s' = \alpha t = \frac{Vt}{RC} \quad \text{--- (3)}$$

at $t = T_s$, $V_s' = V_s$ from figure

$$\therefore V_s = \frac{VT_s}{RC} \quad \text{--- (4)}$$

$$e_d = \frac{|V_s - V_s'|_{\max}}{V_s} = \frac{V(T_s/2)}{RC} \cdot \frac{(T_s/2)}{2RC}$$

$$= V \left[\frac{T_s}{2RC} \cdot \frac{T_s}{4RC} \right] = \frac{VT_s}{RC} \left[\frac{1}{2} \cdot \frac{T_s}{4RC} \right]$$

$$= \frac{T_s}{8RC}$$

$$\therefore e_d = \frac{T_s}{8RC}$$

$$e_d = \frac{e_s}{8} = \frac{e_t}{4}$$

or

$$e_s = 2e_t = 8e_d$$

$$e_d < e_t < e_s$$

\therefore sweep speed error (e_s) is most dominant and displacement error (e_d) is the least-severe one.

Miller and Bootstrap Time-base Generators

Basic Principles

— To improve the linearity of time-base waveforms, the feedback is used.

— The basic exponential sweep circuit in which S opens to form the sweep is shown below fig(a).

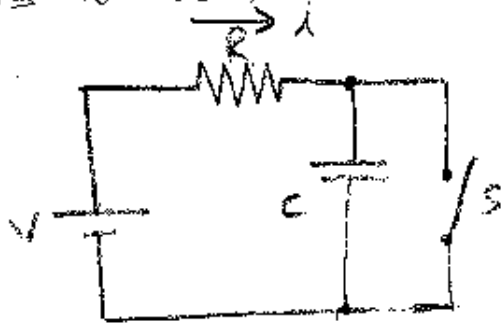

Fig (a): Current decreases exponentially with time

— A linear sweep cannot be obtained from this circuit because as the capacitor charges, the charging current decreases and hence the rate at which the capacitor charges; the slope of the output waveform decreases.

— A perfectly linear output can be obtained if the initial charging current $i = \frac{V}{R}$ is maintained constant.

— This can be done by introducing an auxiliary variable generator V , whose generated voltage v is always equal to and opposite to the

voltage across the capacitor, the charging current will be kept constant at $i = \frac{V}{R}$ and perfect linearity is achieved as shown in fig (b).

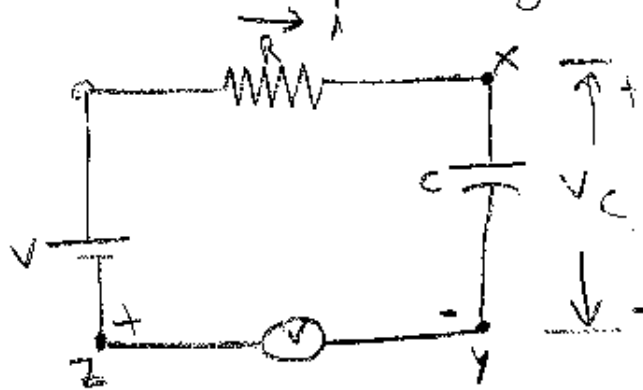

b) Current remains constant

— In fig (b), suppose the point Z is grounded as shown in fig (c), A linear sweep will appear between the point Y and ground and will increase in negative direction.

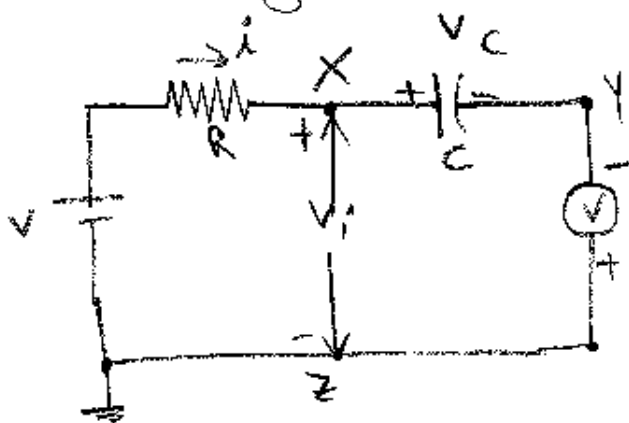

c) with Z grounded

— Let us now replace the fictitious (imaginary) generator by an amplifier with output terminals YZ and input terminal XZ as shown in fig (d).

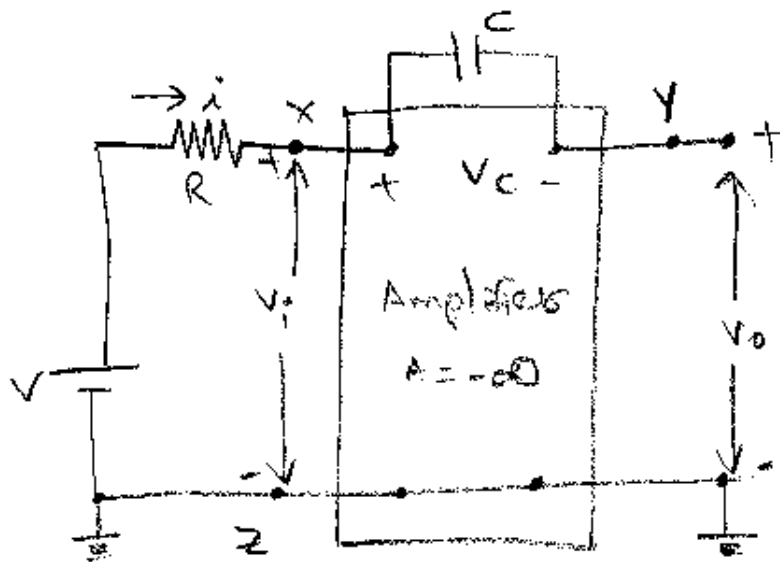

d) Miller Integrator circuit

- Since we have assumed that the generated voltage is always equal and opposite to the voltage across the capacitor, the voltage between X and Z is equal to zero.
- Hence the point X acts as a virtual ground.
- For amplifiers, the input (V_i) = 0V and output (V_o) = finite negative value.

This can be achieved by using an operational integrator with gain of infinity. This type of circuit is called Miller integrator or Miller sweep.

— Suppose the point y in fig (b) is grounded.
 A linear sweep will appear between z and ground and will increase in positive direction.

— Let us replace the fictitious generator by an amplifier with output terminals $z y$ and input terminals $x y$ as shown in fig (c).

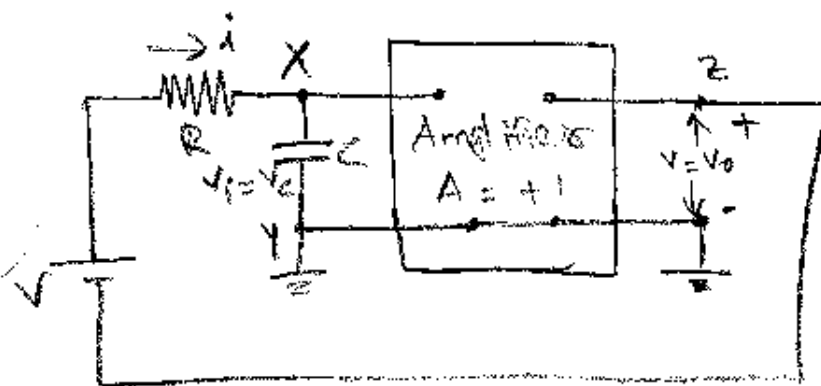

e) Bootstrap Sweep Circuit

— ~~Let~~ Since we have assumed that generated voltage v at any instant is equal to the voltage across capacitor V_c , then V_o must be equal to V_i ($V_o = V_i$) and amplifier gain must be equal to unity and the circuit is called as Bootstrap Sweep.

Transistor Miller Time Base generator

— Miller sweep circuit also generates a ramp voltage using the basic principle.

i) But it differs from the bootstrap sweep circuit in that it generates a negative ramp.

ii) It also uses high gain amplifiers.

iii) It incorporates negative feedback.

— Transistorized Miller time-base generator circuit is shown below:

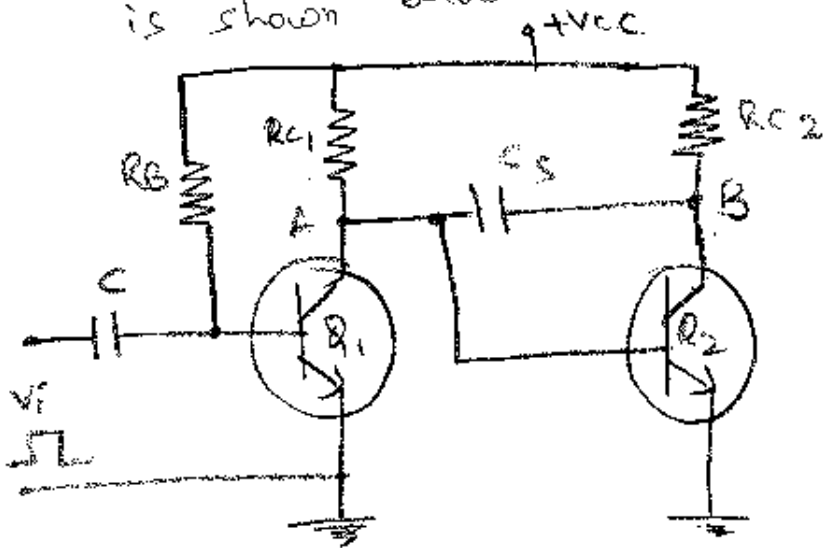

← switch → | ← high gain amplifier →

— Transistor Q_1 = ON-OFF switch
 Q_2 = high gain amplifier

Input V_i = A. Pulse or rectangular voltage

Operation:

— when $V_i = \text{positive}$

Q_1 becomes on and goes into saturation.

The potential at point A, V_A becomes minimum

$$V_A = V_{CE(\text{sat})} = \begin{matrix} 0.3 \text{ for Si} \\ 0.1 \text{ for Ge} \end{matrix}$$

and since this $V_{CE(\text{sat})}$ is connected to base of Q_2 which is not sufficient to drive the transistor Q_2 .

so, Q_2 remains off and potential at point B is maximum and collector current (I_C) is zero

\therefore drop across R_{C2} is zero and potential at B

$V_B = V_{CC}$ and since this is the potential across capacitor

so, voltage across capacitor is

$$V_C = V_{CC} \quad \text{or} \quad V_C = V_{CC}$$

— when $V_i = \text{negative}$

Q_1 is off and the potential at point A is maximum, this maximum voltage now is sufficient to drive the transistor Q_2 , so

Q_2 becomes ON and the potential at B decreases to saturation voltage. Intrinsic Capacitor also decreases to saturation

i.e., it is discharging to saturation voltage $[V_B = V_{CE(sat)}]$

As V_A gradually increases and V_B gradually decreases, the voltage across the capacitor progressively falls.

The result is that C_S discharges linearly.

Thus the voltage V_S across the capacitor C_S is a decreasing i.e., negative going ramp.

— when $Q_1 = ON$

i.e., during positive cycle, the charging is through R_{C2} and C_S

$$T_D = R_{C2} C_S$$

where $T_D =$ Return time or Rectifying time or fly back time.

— when $Q_1 = OFF$

i.e., during negative cycle, discharging is through R_{C1} and C_S

$$T_S = R_{C1} C_S$$

where $T_S =$ Sweep time

Expression for Sweep speed error

Below fig(a) shows the general circuit of Miller sweep generator

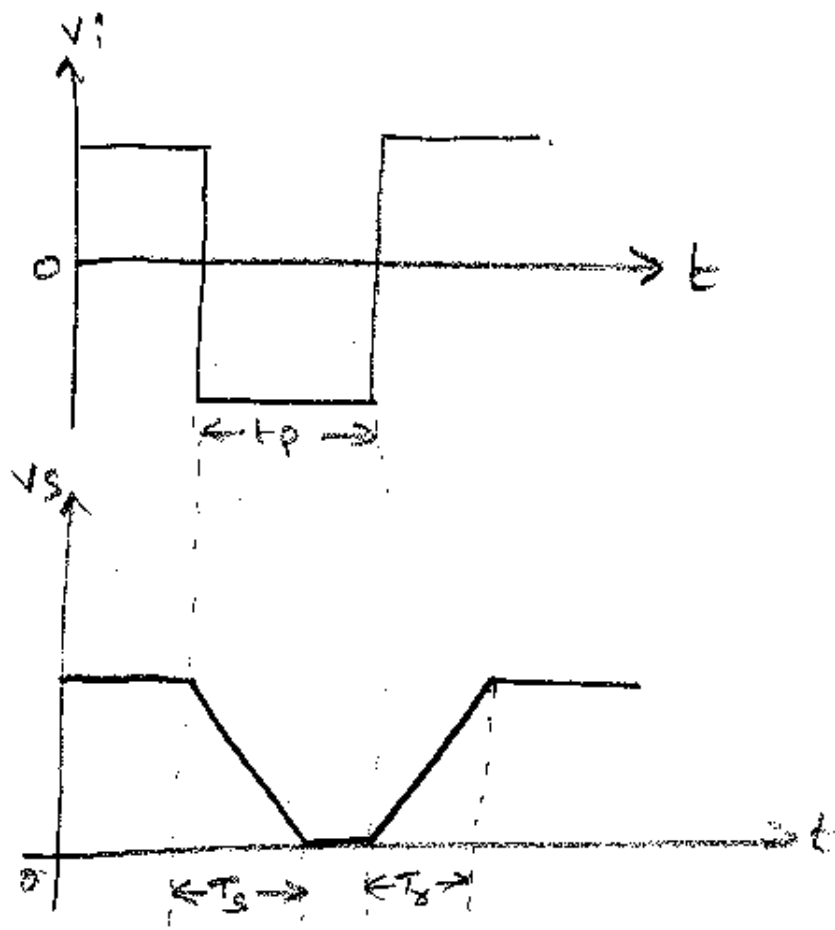

$$T_s \leq T_p$$

Expression for sweep-speed error

— Below fig (a) shows the general circuit and replacing the amplifiers by its equivalent circuit, fig (a) can be redrawn as fig (b).

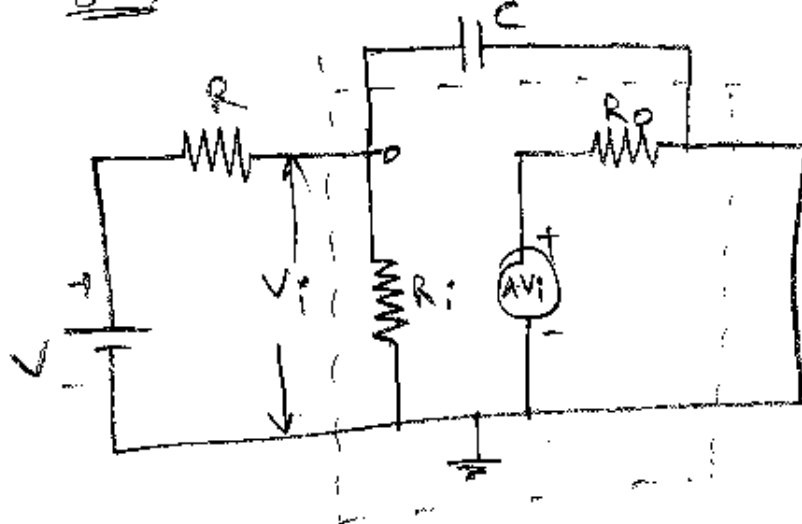
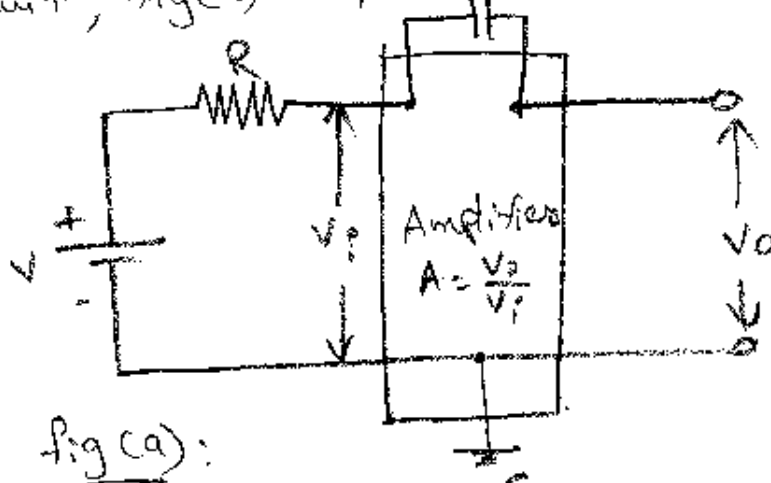

where R_i = input resistance

R_o = output resistance

A = open-loop voltage gain

$$\text{since } A = \frac{V_o}{V_i}$$

— For emitter follower or source follower, Gain (A) is approximately equal to 1, then V_i follows V_o

$$\therefore V_o = A V_i$$

It means that there is no voltage drop across R_o .

$\therefore R_o = 0$ (shorted or negligible)

The circuit further modified as shown in Fig (c).

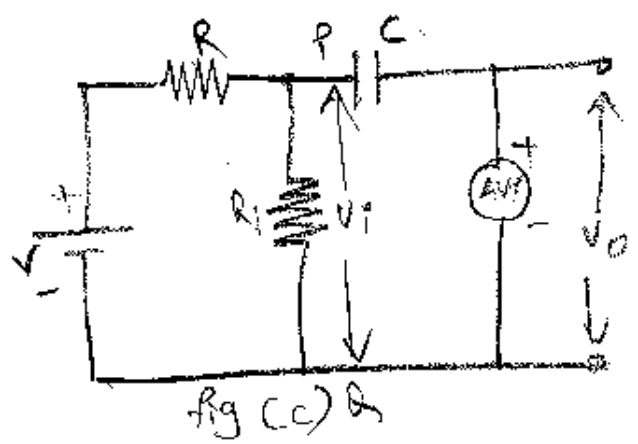

— At $t = \infty$

$$X_c = \frac{1}{2\pi f C} = \frac{t}{2\pi C} = \infty$$

$\therefore C$ acts as open circuit

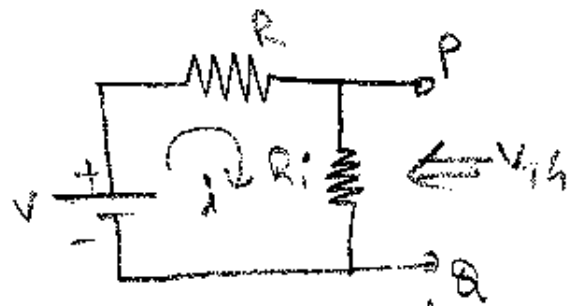

Thevenin's equivalent at point P is

$$i = \frac{V}{R + R_i}$$

$$V_{Th} = V_{PQ} = \lambda R_i = \left(\frac{V}{R+R_i} \right) R_i$$

$$R_{Th} = R \parallel R_i = \frac{R R_i}{R+R_i}$$

$$\therefore V_o = A V_i = A V_{Th} = \frac{A V R_i}{R+R_i}$$

The circuit further modified as shown in fig(d)

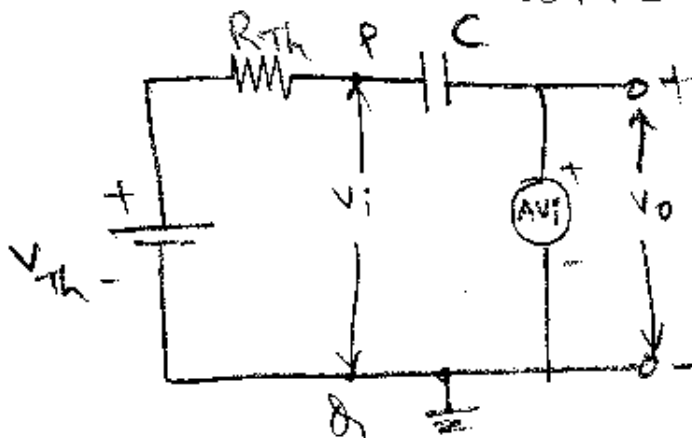

$$\text{Sweep error } (e_s) = \frac{\text{maximum sweep amplitude}}{\text{maximum output (at } t = \infty)}$$

$$e_s = \frac{V_s}{V_o(\text{at } t = \infty)} = \frac{V_s}{\frac{A V R_i}{R+R_i}} = \frac{V_s (R+R_i)}{A V R_i}$$

$$e_s = \frac{V_s}{A V} \left[\frac{R}{R_i} + 1 \right]$$

$$\therefore \boxed{e_s = \frac{V_s}{A V} \left[1 + \frac{R}{R_i} \right]}$$

$$e_t = \frac{1}{2} e_s, \quad e_d = \frac{1}{8} e_s$$

Transistor Bootstrap time base generator

Below fig (a) shows the transistor bootstrap time-base generator.

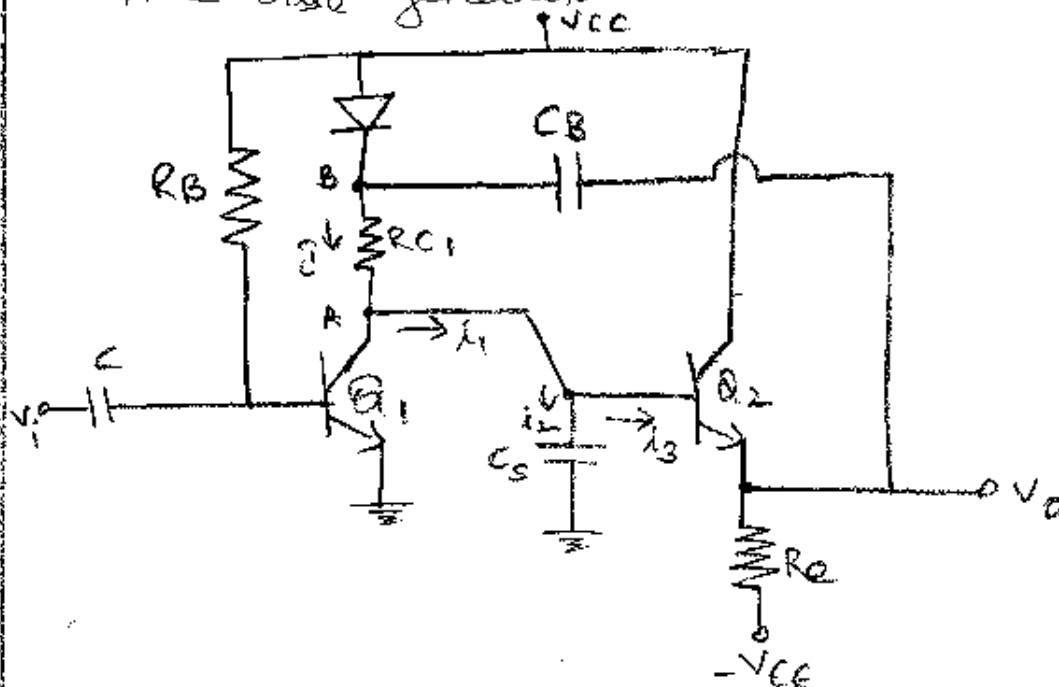

← Switch → ← Emitter follower

Q_1 = ON-OFF switch

Q_2 = Emitter follower

V_i = Pulse voltage in rectangular wave

Operation:

— when V_i = Positive

Q_1 becomes ON i.e.; goes into saturation

∴ Potential at point A, $V_A = V_{CE(sat)} = 0.3V$

output voltage (V_o) = $V_A - V_{BE}(Q_2)$ (in active region)

$$= 0.3 - 0.6$$

$$V_o = \underline{\underline{-0.3V}}$$

— The emitter of Q_2 is coupled to the collector of Q_1 through the capacitor C_B .

Hence point B becomes negative w.r. to V_{CC} .

Diode D readily conducts with the result that potential $V_B \approx V_{CC}$.

— When $V_i = \text{negative}$

Q_1 becomes o.f.f. The potential of A rises.

This increase of voltage at A is transmitted to B through Q_2 and capacitor C_B .

The result is that the potential of B also rises by the same amount. This is the basic principle of bootstrapping.

Thus V_B rises from V_{CC} to $(V_{CC} + V_A)$

Let I denote the current through R_{C1}

$$\therefore I = \frac{V_B - V_A}{R_{C1}} = \frac{V_{CC}}{R_{C1}} \quad \text{--- (1)}$$

$$\text{since } V_B = V_{CC} + V_A$$

$$V_{CC} = V_B - V_A$$

since both V_{CC} and R_{C1} are of fixed magnitude,

the ratio $\left(\frac{V_{CC}}{R_{C1}}\right)$ is constant.

∴ Current (I) is of constant magnitude.

— from the circuit

$$I = i_1, \text{ since } Q_1 = \text{off and } \Sigma C = 0$$

$$\text{but } i_1 = i_2 + i_3$$

where $i_3 =$ base current of Q_2

since Q_2 is an emitter follower, its input impedance (R_i) is very very high.

∴ i_3 is practically zero.

$$\therefore i_1 = i_2$$

$$\text{but } i_1 = \Sigma$$

$$\boxed{i_2 = \Sigma} \text{ a constant current.}$$

As this current flows through the capacitor C_s , a ramp voltage develops across it.

— For an emitter follower, voltage gain is almost unity.

∴ output voltage (V_o) is also a ramp voltage.

Thus the bootstrap circuit generates a ramp voltage.

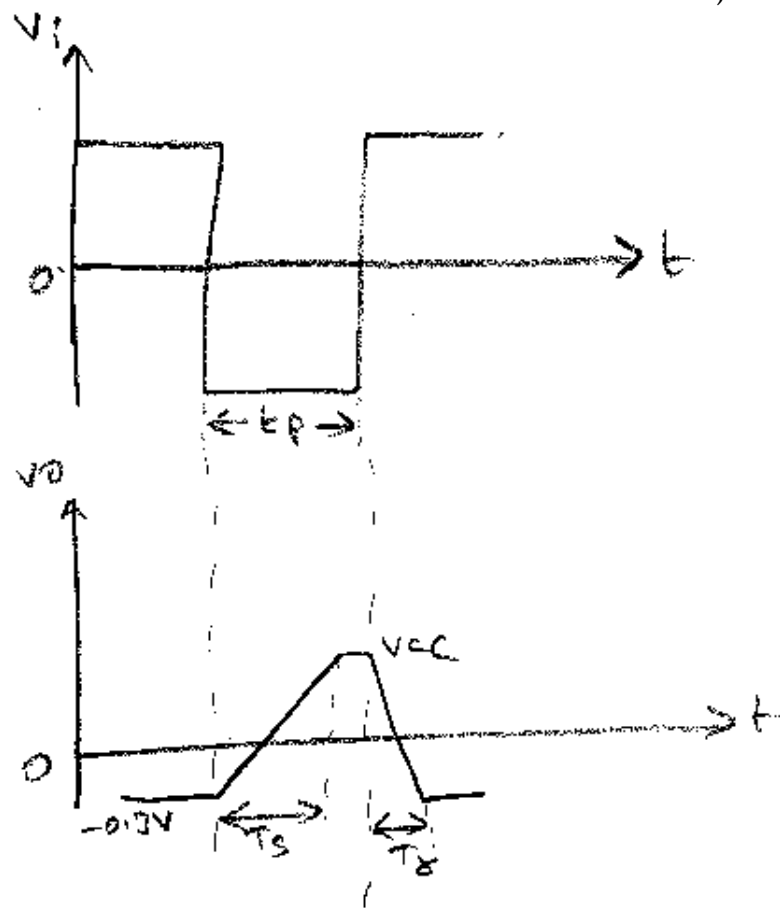

$t_p =$ Pulse width

$T_s =$ sweep time

$$T_s \leq t_p$$

$$T_s = \text{Return time} = \frac{T_s}{10}$$

$$\text{Time constant} = R_c C_s = T_s$$

Expression for Sweep error (e_s)

— In order to obtain an expression for the sweep error, consider the fig (a) and replacing the amplifier by its equivalent circuit, modified circuit is shown in fig (b).

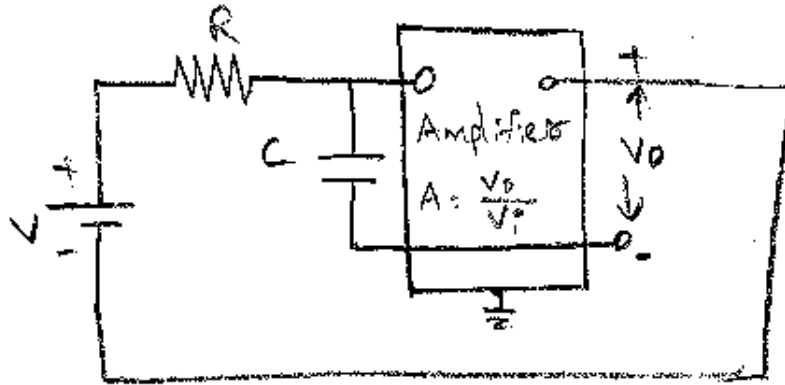

fig (a)

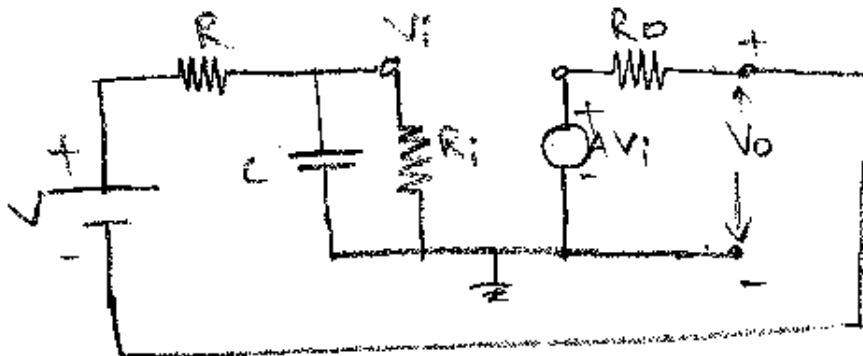

fig (b)

R_i = Input resistance

R_o = Output resistance

A = open loop gain of the amplifier

$$\text{Sweep error } (e_s) = \frac{V_s}{V_o \text{ (at } t = \infty)}$$

At $t = \infty$, C acts as open-circuit. The circuit of fig (b) at $t = \infty$ is shown in fig (c).

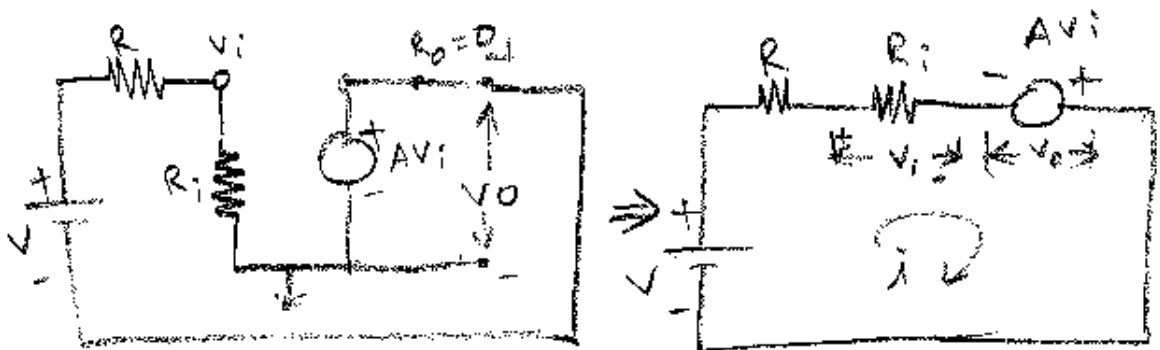

fig (c)

$$V_0 = AV_i = A(iR_i) \quad \text{--- (1)}$$

$$\text{since } V_i = iR_i$$

Apply KVL

$$V - iR - iR_i + V_0 = 0$$

$$V - i(R + R_i) + V_0 = 0$$

$$i = \frac{V + V_0}{R + R_i} \quad \text{--- (2)}$$

sub (2) in (1)

$$V_0 = A(iR_i) = AR_i \left[\frac{V + V_0}{R + R_i} \right]$$

$$V_0(R + R_i) = A(V + V_0)R_i$$

$$V_0R + V_0R_i = AVR_i + AV_0R_i$$

$$V_0[R + R_i - AR_i] = AVR_i$$

$$V_o [R + R_i(1-A)] = AV R_i$$

$$V_o = \frac{AV R_i}{R + R_i(1-A)} \quad \text{--- (3)}$$

$$e_s = \frac{V_s}{V_o(\text{at } t = \infty)} = \frac{V_s}{\frac{AV R_i}{R + R_i(1-A)}}$$

$$= \frac{V_s [R + R_i(1-A)]}{AV R_i} = \frac{V_s}{AV} \left[\frac{R + R_i(1-A)}{R_i} \right]$$

$$e_s = \frac{V_s}{AV} \left[\frac{R}{R_i} + (1-A) \right]$$

If the open loop gain of the amplifier (A) is unity,

then

$$e_s = \frac{V_s}{AV} \left[\frac{R}{R_i} \right]$$

$$e_t = \frac{1}{2} e_s$$

$$e_d = \frac{1}{8} e_s$$

Comparison between Miller and Bootstrap sweep circuit :

Although both the Miller and Bootstrap sweep circuits generate ramp voltage using the same basic principle, they differ in some aspects

Bootstrap sweep circuit

- 1) The circuit employs positive feedback.
- 2) The circuit generates positive going ramp.
- 3) The circuit employs an emitter follower whose gain is nearly unity.
- 4) The amplifiers must have high input resistance.

Miller sweep circuit

- 1) The circuit employs negative feedback.
- 2) The circuit generates negative going ramp.
- 3) The circuit requires an amplifier whose gain is very very large (ideally infinite).
- 4) Amplifier with high input resistance is not very essential.

Summary

Current time base generator

— "A current time-base generator is one that provides an output current waveform, a portion of which exhibits a linear variation with respect to time."

— This linearly varying current waveform can be generated by applying a linearly varying voltage waveform generated by a voltage time-base generator across a resistor.

Alternatively, a linearly varying current waveform can be generated by applying a constant voltage across an inductor.

— Use:
linearly varying currents are required for magnetic deflection applications.

— In voltage time base generators, if a constant current is passed through a capacitor, the voltage across the capacitor is a ramp in accordance with the relation $V_c = \left(\frac{I}{C}\right)t$ or

$$V_c = \alpha t.$$

— If this ramp voltage is applied to a fixed resistor, the current which results is a ramp current (since the voltage varies linearly with time, the resulting current also varies linearly with time, since resistance is a linear circuit element).

— This is a direct method of generating a ramp current.

A ramp current has the waveform shown.

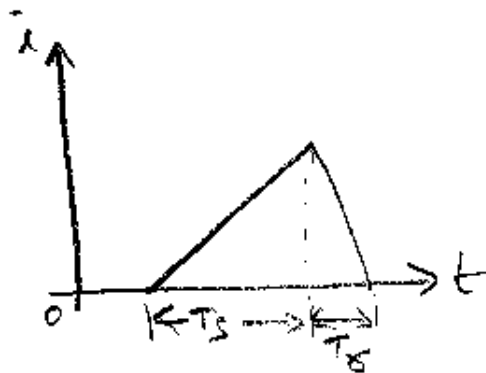

$T_s = \text{Sweep time}$

$T_s = \text{Return time}$

Practical method of generating current ramp

— If a constant voltage is maintained across an inductor, the current which flows through the inductor is a ramp.

— Consider a coil of inductance L Henry.
Let a voltage V be applied across it, and let i denote the resulting current.

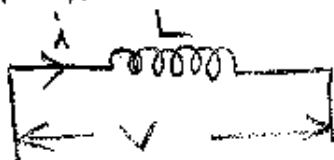

$$i = \frac{1}{L} \int v dt$$

Since V is constant

$$i = \frac{V}{L} \int dt = \left(\frac{V}{L}\right)t = \alpha t$$

Since V & L are fixed, i is proportional to t . Hence the current in the inductor is a ramp.

→ However, in practice, a coil has some resistance and no coil can be considered as purely inductive.

An inductor is a series combination of pure inductance and a resistance.

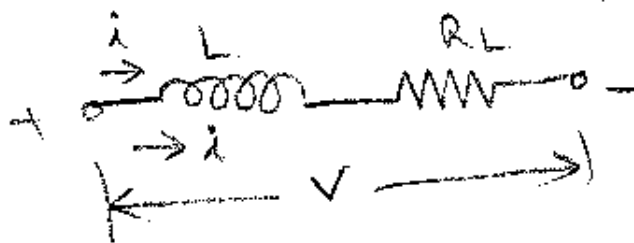

If a voltage of constant magnitude is applied across a practical inductor, the resulting current is

$$i = \frac{V}{R_L} \left[1 - e^{-t/\tau} \right], \text{ where } \tau = \frac{L}{R_L}$$

It indicates that the current increases exponentially with respect to time.

Hence the waveform is non-linear.

— In order to linearise the current waveform, it can be shown that a trapezoidal voltage needs to be applied across the practical inductor.

Apply KVL

$$V = L \frac{di}{dt} + iR_L \quad \text{--- (1)}$$

let i be a ramp current, $i = kt$

$$V = L \frac{d}{dt}(kt) + (kt)R_L$$

where $k = \text{constant}$

$$V = Lk + (kR_L)t \quad \text{--- (2)}$$

eqn (2) states that V is a trapezoidal voltage

$Lk = \text{step voltage}$ (because $Lk = \text{a constant}$)

$kR_L = \text{ramp voltage}$ (because $kR_L = \alpha$, a constant)

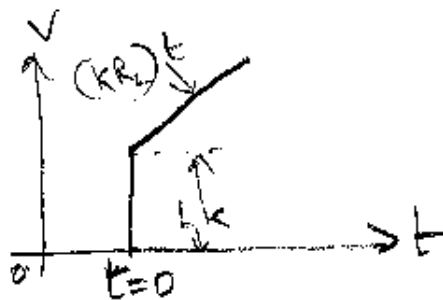

Thus, by applying a trapezoidal voltage across an inductor, a ramp current waveform can be generated.

Basic Current Sweep Circuit

Below fig (a) shows a simple transistor current sweep circuit.

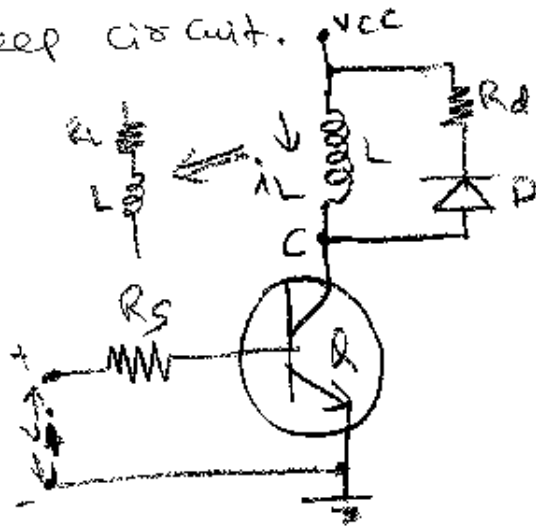

fig (a): A simple current sweep circuit

Here the transistor is used as a switch and inductor L in series with transistor is bridged across the supply voltage.

R_D = switch.

R_D = sum of diode forward resistance and damping resistance.

R_S = resistance of input voltage source.

v_i = Input signal

The gating waveform shown in fig (b) is applied to the base of the transistor is in two levels.

These levels are selected such that when

the input is at = lower level, Q = Cut-off
 = upper level, Q = Saturation

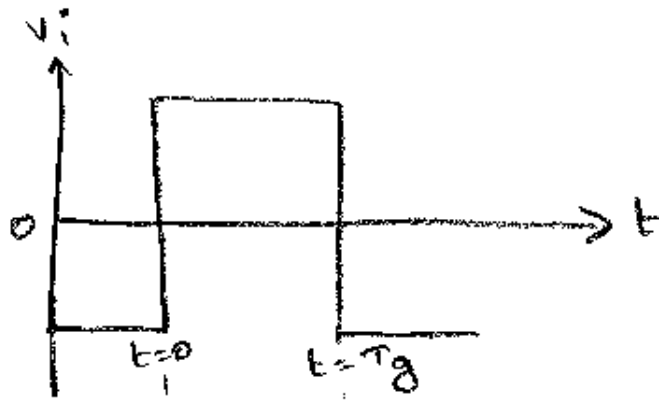

fig(b): Input gating waveform

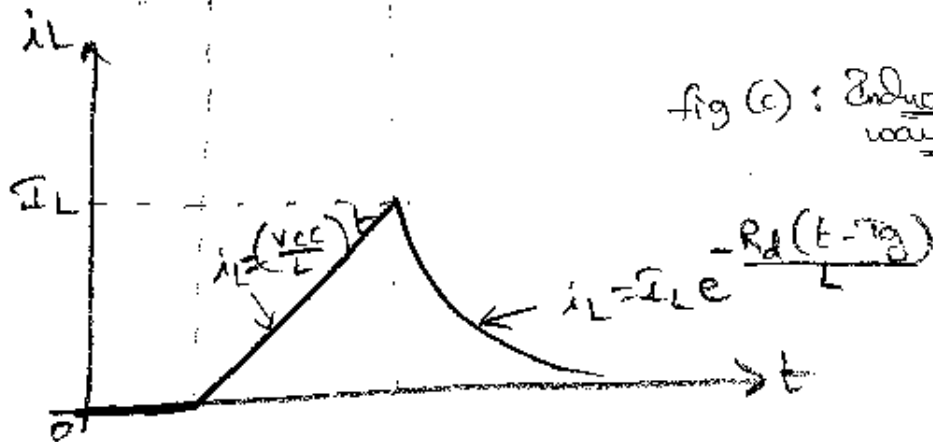

fig(c): Inductor current waveform

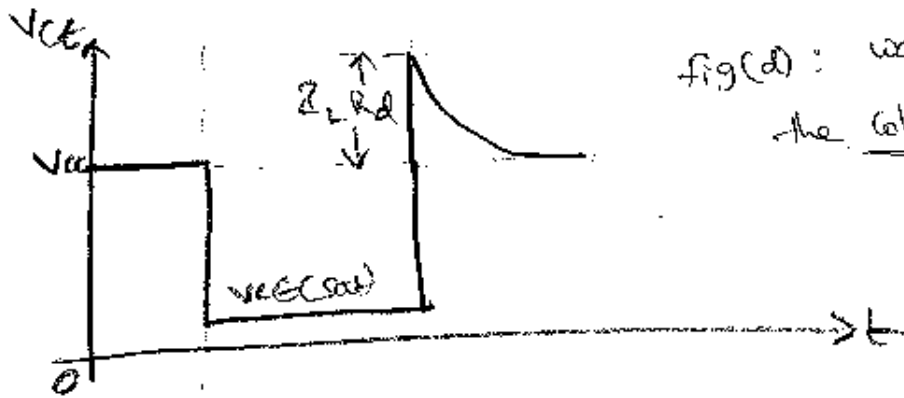

fig(d): waveform of the collector voltage

i) $t < 0$

The input to the base is at its lower level (negative)

so, $Q = \text{cut-off}$.

Hence no currents flow in the transistor and

$$\boxed{i_L = 0}, \quad \boxed{V_{CE} = V_{CC}}$$

ii) $t = 0$

The gate signal goes to its upper level (positive) so the transistor conducts and goes into saturation.

\therefore collector voltage falls to $V_{CE(sat)}$

$$V_{CE} = V_{CE(sat)}$$

and entire supply voltage V_{CC} is applied across the inductor.

$$i = \frac{V_{CC} - V_C}{\text{Impedance of } R_L \times L}$$

so, the current through the inductor

$$i_L = \frac{1}{L} \int V_{CC} dt = \left(\frac{V_{CC}}{L} \right) t$$

increases linearly with time.

iii) $t = T_g$

The gate signal comes to its lower level and $Q = \text{Cut-off}$.

During sweep times T_g (from $t=0$ to $t=T_g$), the diode $D = \text{reverse biased}$ and hence it does not conduct.

At $t = T_g$, when $Q = \text{Cut-off}$, no current flows through it, since the current through the inductor cannot change instantaneously, it flows through the

diode and diode conducts.

Hence there will be a voltage drop of $I_L R_d$ across the resistance R_d .

So, at $t = T_g$, the potential at the collector terminal rises abruptly to $V_{cc} + I_L R_d$

i.e.; there is a voltage spike at the collector at $t = T_g$.

The duration of the spike depends on the inductance of L , but the amplitude of the spike does not.

iv) $t > T_g$

The inductor current decays exponentially to zero with a time constant $\tau = \frac{L}{R_d}$.

So, the voltage at the collector also decays exponentially and settles at V_{cc} under steady-state conditions.

— let us consider RL

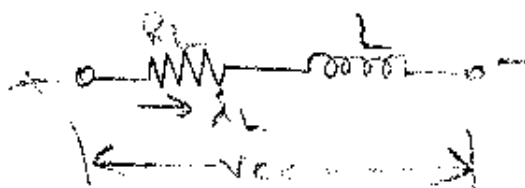

Apply KVL

$$V_{cc} = L \frac{di_L}{dt} + i_L R_L$$

Divide throughout by L

$$\frac{di_L}{dt} + \left(\frac{R_L}{L}\right) i_L = \frac{V_{cc}}{L}$$

$$\frac{di_L}{dt} + \left(\frac{1}{\tau}\right) i_L = a$$

where $\tau = \frac{L}{R_L}$, $a = \frac{V_{cc}}{L}$

The solution of this differential equation is

$$i = CF + PZ$$

$$CF = k e^{-t/\tau} = k e^{-t/LR} = k e^{-\frac{R}{L}t}$$

$$PZ = \frac{R}{Z} PZ = \frac{V}{Z}$$

$$PZ = \frac{V}{R} = \frac{V_{cc}}{L} \times \frac{L}{R_L} = a\tau$$

$$i_L = k e^{-t/\tau} + a\tau$$

To find k

at $t=0$, $i=0$

$$0 = k e^0 + a\tau$$

$$k = -a\tau$$

$$i_L = -a\tau e^{-t/\tau} + a\tau$$

$$= a\tau [1 - e^{-t/\tau}]$$

$$i_L = a \pi \left[1 - \left(1 - \frac{t}{\pi} + \frac{(t/\pi)^2}{2!} - \frac{(t/\pi)^3}{3!} + \dots \right) \right]$$

$$= a \pi \left[1 - \left(1 - \frac{t}{\pi} \right) \right]$$

$$i_L = a \cancel{\pi} \times \frac{t}{\cancel{\pi}} = at$$

$$i_L = \left(\frac{V_{CC}}{L} \right) t$$

Hence the current i_L is a ramp

Generation of Trapezoidal Voltage

— A trapezoidal voltage is applied across an inductor to generate a ramp current.

— The trapezoidal voltage required is generated using either Miller Integrator circuit or Operational Amplifier.

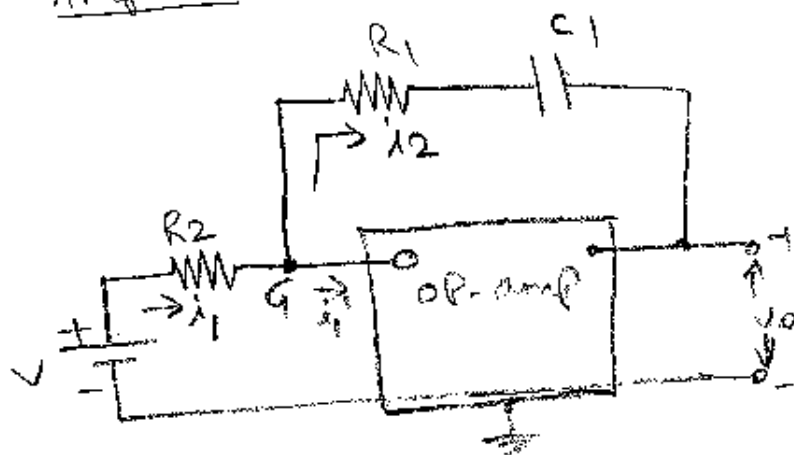

— for an op-amp

$$R_i = \infty$$

$$R_o = 0$$

$$A = \infty$$

there is a virtual ground at input terminals

— since $R_i = \infty$, $i_i' = 0$ and $V_g = 0$

$$i_1 = \frac{V - V_g}{R_2} = \frac{V - 0}{R_2} = \frac{V}{R_2} \quad \text{--- (1)}$$

$$i_2 = i_1 - i_i' = i_1, \text{ since } i_i' = 0$$

$$\therefore i_1 = i_2 = \frac{V}{R_2} \quad \text{--- (2)}$$

output (V_o) = V_g - (voltage drop across R_1 & C_1)

$$V_o = V_g - i_2 R_1 - \frac{1}{C_1} \int i_2 dt$$

sub eqn (2)

$$V_o = 0 - \left(\frac{V}{R_2}\right) R_1 - \frac{V}{R_2 C_1} \int dt$$

$$V_o = -\frac{V R_1}{R_2} - \frac{V}{R_2 C_1} t$$

$$\text{let } -\frac{V R_1}{R_2} = A, \quad -\frac{V}{R_2 C_1} = B$$

$$\therefore \boxed{V_o = A + B t}$$

where $A = \text{step voltage}$
 $B = \text{Ramp voltage}$

$\therefore V_o = \text{step} + \text{Ramp} = \text{trapezoidal voltage}$

Linearity Correction through adjustment of Driving waveform

- From fig (c), the current waveform i_L is not perfectly linear.
- A non-linearity exist because as the current in the inductor (yoke) increases, the voltage drop across the series resistance also increases and hence the voltage across the inductor decreases, and so the rate of rise of the current in the inductor decreases as well.
- If the voltage developed across the resistor is compensated, then linear waveform can be obtained.
- fig (a) shows a method of compensating the voltage drop across series resistor to obtain a linear current waveform.

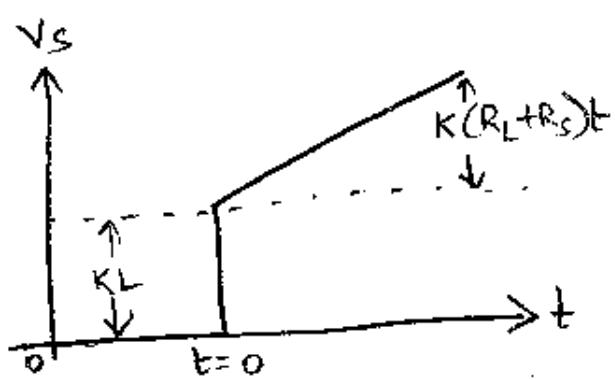
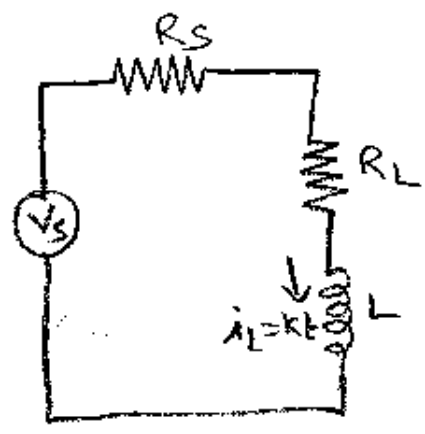

fig (a):



— The driving voltage source has a Thevenin's resistance R_s and total circuit resistance is $R_s + R_L$.

— If the inductor current is to be perfectly linear, i.e.; if $i_L = kt$, then the voltage source waveform must be

$$V_s = L \frac{di_L}{dt} + (R_s + R_L) i_L$$

$$V_s = Lk + (R_s + R_L)kt$$

This applied waveform consists of a step followed by a ramp. Such a waveform is called trapezoidal.

— so, considering the resistance of the yoke, transistor and source to obtain a linear current waveform a trapezoidal rather than a step signal should be applied.

— If the voltage source V_s in series with the resistance R_s is replaced by a current source $i_s = \frac{V_s}{R_s}$ in parallel with a resistance R_s as shown in fig (b) below, the current source must furnish a current

$$i_s = \frac{V_s}{R_s} = \frac{kL}{R_s} + \left[1 + \frac{R_L}{R_s} \right] kt$$

This is also a step followed by a ramp. Hence the waveform of the current source must also be trapezoidal.

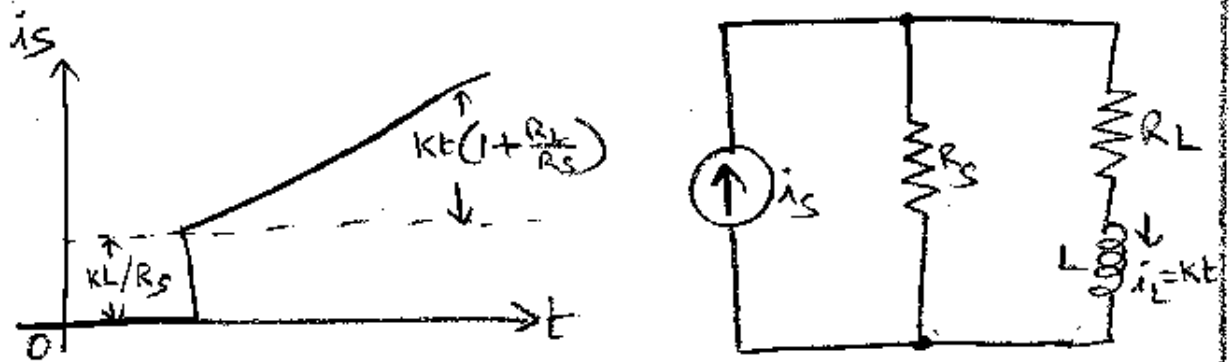

fig (b)

— At the end of the sweep, the current will return to zero exponentially with a time constant $(\tau) = \frac{L}{(R_S + R_L)}$.

— Normally, $R_S \gg R_L$. Therefore neglecting R_L ,

$$\tau = \frac{L}{R_S}$$

i) If $R_S = \text{small}$

The time constant is large and so the current decays very slowly, but the peak voltage developed across the current source will be small.

ii) If $R_S = \text{large}$

The time constant is small and so the current decays very fast but the peak voltage developed across the source will be large.

∴ As a compromise, a damping resistor

R_d is connected in parallel to the yoke.

— If R is the parallel combination of R_s and R_d , then the time constant is $\tau = \frac{L}{R}$.

Modified voltage sweep circuit to generate trapezoidal waveform

— The trapezoidal voltage required to be applied across an inductor to be applied across an inductor to generate a ramp current can also be obtained using the circuit shown below in fig (a):

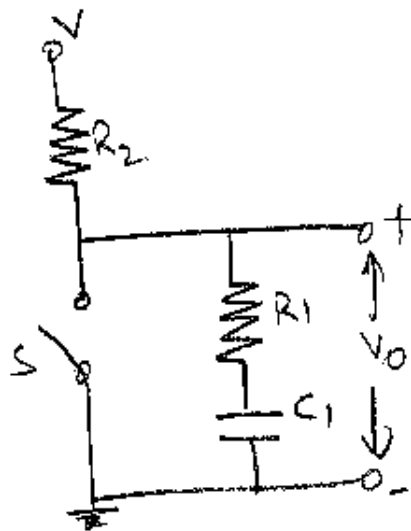

fig (a): circuit for generating trapezoidal waveform

— In this modified voltage sweep circuit, there is a resistor R_1 in series with the sweep capacitor C_1 .

R_2 is another resistance, usually much larger

then R_1 and S is a switch,

i) at $t=0$

let switch S is opened, the capacitor acts as short-circuit.

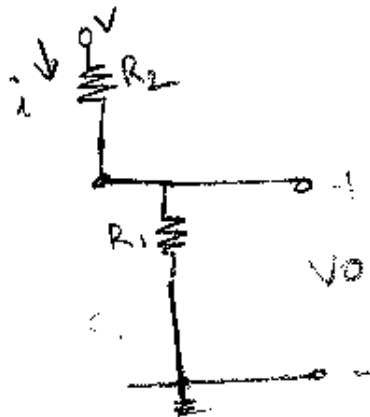

$$i = \frac{V}{R_1 + R_2} \quad \text{--- (1)}$$

$$i = \frac{V - V_0}{R_2} \quad \text{--- (2)}$$

$$V_0 = V - iR_2 = V - \frac{VR_2}{R_1 + R_2}$$

$$\text{and } V_0 = iR_1 = \frac{V R_1}{R_1 + R_2}$$

$$\text{but } R_1 + R_2 \approx R_2$$

$$\therefore V_0 = \frac{V R_1}{R_2}$$

ii) for $t > 0$

capacitor exponentially increases and constant (i) exponentially decreases with time. constant $(R_1 + R_2)C_1$

$$i = \left(\frac{V}{R_1 + R_2} \right) e^{-t / (R_1 + R_2) C_1}$$

$$V_0 = V - \frac{VR_2}{R_1 + R_2} \cdot e^{-t / (R_1 + R_2) C_1}$$

$$\text{since } R_2 \gg R_1, \quad e^{-t / (R_1 + R_2) C_1} \approx e^{-t / R_2 C_1}$$

$$\text{but } e^{-t / R_2 C_1} = 1 - \frac{(t / R_2 C_1)}{1!} + \frac{(t / R_2 C_1)^2}{2!} - \frac{(t / R_2 C_1)^3}{3!} + \dots$$

neglecting higher order terms

$$e^{-t/(R_2 C_1)} = 1 - \frac{t}{R_2 C_1} + \frac{(\cancel{t/R_2 C_1})^2}{2} = 1 - \frac{t}{R_2 C_1} \left(1 - \frac{t}{2R_2 C_1}\right)$$

$$V_0 = V - \frac{VR_2}{R_2} \left[1 - \frac{t}{R_2 C_1} \left(1 - \frac{t}{2R_2 C_1}\right)\right]$$

$$= V - V \left(1 - \frac{t}{R_2 C_1}\right)$$

$$= \cancel{V} - \cancel{V} + \frac{Vt}{R_2 C_1}$$

$$\therefore V_0 = \frac{Vt}{R_2 C_1}, \text{ at } t > 0$$

$$V_0 = \frac{VR_1}{R_2}, \text{ at } t = 0$$

$$\therefore \text{Total output voltage } (V_0) = \frac{VR_1}{R_2} + \frac{Vt}{R_2 C_1}$$

\swarrow step voltage \searrow Ramp Voltage

Hence V_0 represents a trapezoidal voltage.

1